

“\*” MARK AS CRITICAL SIZE  
 UNDEFINED TOLERANCE REFER TO  
 GB/T14486-2008-MT6  
 UNIT:MM

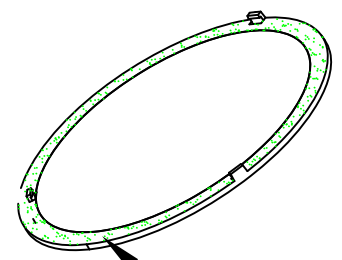

背面晒纹

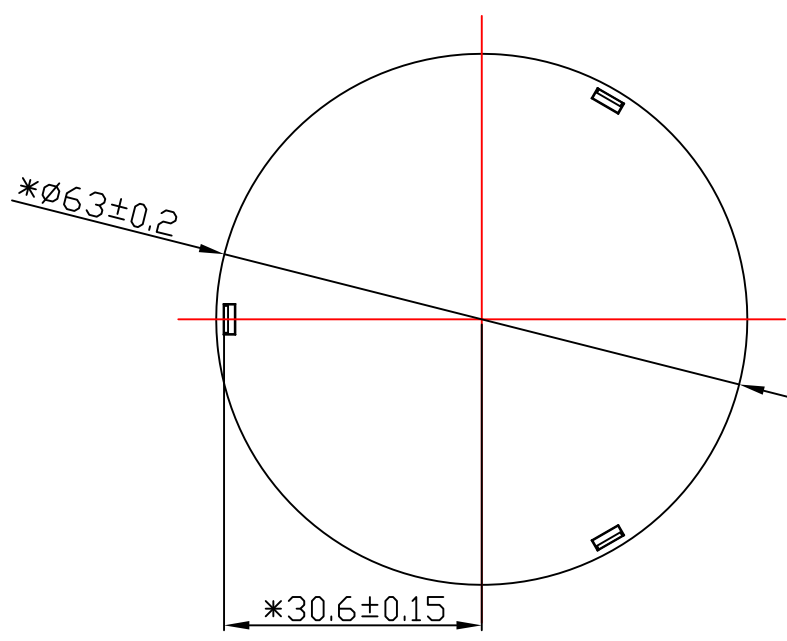
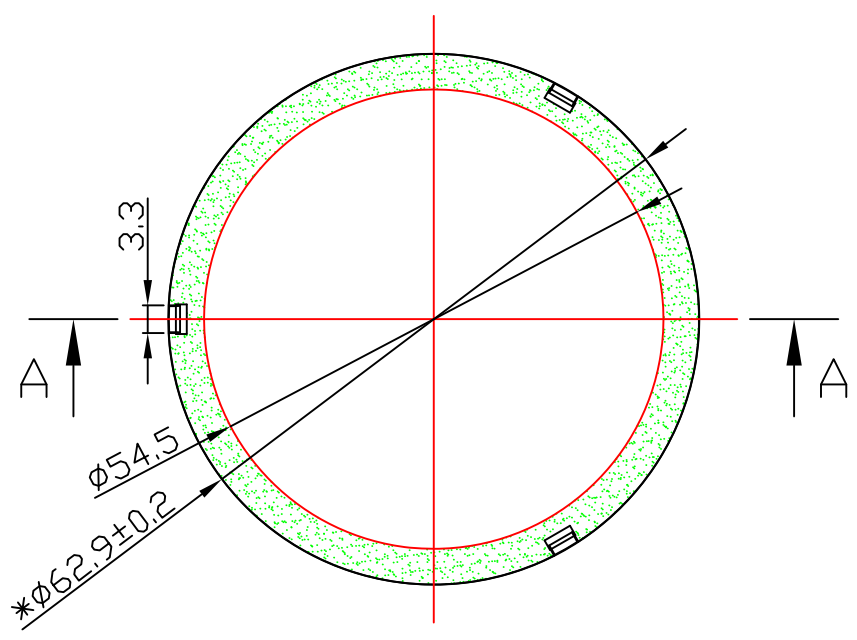
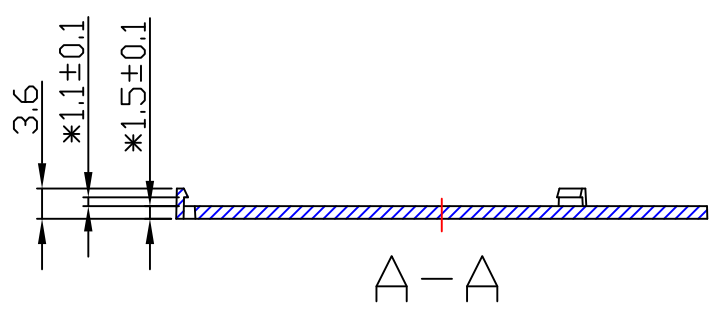

				MATERIAL: PC FINISH: NA		P/N: 97.70.379.00		版本/REV KO	
						产品名称 PRODUCT NAME		EW防尘片D63H1.5	
						客户代号 CUSTOMER ID		NT	
						客户编号 CUSTOMER CODE		EW-D63防尘片	
标记 MARK	处数 NO.OF MODIF.	更改内容 MODIFICATIONS		签名 SIGNED BY	更改日期 MODIF. DATE				
设计 DESIGNER		制图 DRAWN BY		比例 SCALE	1:1				
工艺 TECHNICAN		审核 CHECKED BY		视角 1st ANGLE PROJECTION					
批准 APPROVED BY		日期 DATE(DD-MM-YYYY)	07-03-2023	页数 PAGE	SHEET 1 OF 1	ENGINEERING DRAWING			